

УДК 620.9

<https://doi.org/10.34185/tpm.5.2019.09>

Качан Ю.Г., Кузнецов В.В.

## Щодо техніко-економічних показників використання вітро- та фотоелектричних станцій в системах живлення нетягових споживачів залізничних електромереж

Kachan Yu., Kuznetsov V.

### About technical and economic indicators of wind and photoelectric stations use in the systems of network consumer railway supply systems

*Мета.* Проаналізувати техніко-економічні показники використання вітро- та фотоелектричних станцій в системах живлення нетягових споживачів залізничних електромереж.

*Методика дослідження* ґрунтується на сучасних методах обчислювальної математики, статистики та аналізу інформації з використанням сучасних комп'ютерних технологій.

*Результати дослідження.* Авторами проведено аналіз існуючих на сьогодні передумов використання електричної енергії, яка отримана від відновлювальних джерел (вітро- та фотоелектричних станцій) для живлення нетягових споживачів залізничних електромереж. Авторами зазначається, що задля надійного електропостачання нетяговим споживачам за наявності випадкового характеру вітрового потоку або інтенсивності сонячного випромінювання, потужності вітро- та фотоелектричних станцій необхідно буде суттєво завищувати, що призводить до значного збільшення капітальних затрат на будівництво зазначених електростанцій. В роботі наведено приклади впровадження варіантів побудови вищевказаних вітро- та фотоелектричних станцій для змінного характеру швидкості вітру та інтенсивності сонячного випромінювання для конкретних регіонів України (місто Василівка Запорізької області). Авторами наведено варіанти принципів схеми вітро-, сонячної та комбінованої електричних систем живлення нетягових споживачів. Надано інформацію щодо техніко-економічних показників найрозповсюджених на ринку України вітчизняних фотомодулів та вітроустановок.

*Наукова новизна роботи* відображена в прикладах впровадження варіантів побудови вітро- та фотоелектричних станцій для змінного характеру швидкості вітру та інтенсивності сонячного випромінювання для конкретних регіонів України.

*Практичне значення.* Приведений розрахунок вартості необхідної кількості джерел живлення на вітровій, сонячній та комбінованій електростанціях допомагає обрати найменш затратний варіант впровадження відновлювальних джерел електроенергії для нетягових споживачів залізничних мереж.

*Ключові слова:* відновлювані джерела енергії, фотоелектрична установка, мережі електропостачання залізничного транспорту, нетягові споживачі залізничних електромереж, виробництво електроенергії, інтенсивність сонячного випромінювання, швидкість вітрового потоку, капітальні витрати.

*Purpose.* To analyze the technical and economic indicators of the use of wind and photovoltaic stations in the power supply systems of non-traction consumers of railway power grids.

*The research methodology* is based on modern methods of computational mathematics, statistics and information analysis using modern computer technology.

*Findings.* The authors analyze the current prerequisites for the use of electricity generated from renewable sources (wind and photovoltaic stations) to supply non-traction consumers of railway power grids. The authors note that for reliable power supply to non-traction consumers in the presence of accidental wind flow or intensity of solar radiation, the capacity of wind and photovoltaic plants will need to be significantly overestimated, which leads to a significant increase in capital costs for construction. The paper presents examples of implementation of options for the construction of the above wind and photovoltaic stations for the variable nature of wind speed and intensity of solar radiation for specific regions of Ukraine (Vasylivka, Zaporizhia region). The authors present variants of the basic schemes of wind, solar and combined electric power supply systems for non-traction consumers. Information on technical and economic indicators of the most common domestic photo modules and wind turbines on the Ukrainian market is provided.

*The originality of the work* is reflected in the examples of the introduction of options for the construction of wind and photovoltaic stations for the variable nature of wind speed and intensity of solar radiation for specific regions of Ukraine.

*Practical implications.* The above calculation of the cost of the required number of power sources at wind, solar and combined power plants helps to choose the least expensive option for the introduction of renewable energy sources for non-traction consumers of railway networks.

*Keywords:* renewable energy sources, photovoltaic installation, railway power supply networks, non-traction consumers of railway power grids, electricity production, solar radiation intensity, wind flow rate, capital expenditures.

#### Introduction

As is known [1], at present, advanced world technologies are being introduced into the power supply systems of railway transport, namely the integration of additional renewable energy sources into the existing electrical network. At the same time, a systematic approach is used, aimed at using the potential of wind and solar energy in the railway infrastructure.

The main task of the railway transport of Ukraine is its high-quality and efficient functioning to meet the needs of industry and citizens of the country in safe transportation. At present, in the conditions of constant growth of the cost of electric energy and fuels and lubricants, traditional energy sources do not meet the growing needs. Ukraine is creating various programs for the introduction of energy-saving technolo-

Качан Юрій Григорович – д.т.н., проф. НУ "Запорізька політехніка"  
Кузнецов Віталій Вадимович к.т.н., доц. НМетАУ

Kachan Yu, Ph.D., prof. National University "Zaporozhzhia Polytechnic"  
Kuznetsov V. - Ph.D., Assoc. Prof. NMetAU

gies, the main purpose of which is to save energy resources, reduce the necessary investment in the fuel and energy sector, as well as reduce the harmful effects of energy production on the environment. Therefore, the introduction of alternative energy in the power supply systems of railway transport is a topical issue [2].

Analysis of literature sources and problem statement

The world experience in the introduction of renewable energy sources into the power supply system of railway transport includes the use of wind and solar energy, but in some cases it is also possible to use the mass of air moved during the movement of the train along the railway track to produce electrical energy [3], the authors were the optimal arrangement of mini-wind turbines with a vertical axis (VAWT) was selected, taking into account the speed of the train, the railway, the sections without obstacles and the speed and direction of the wind. However, such developments are not unique [4]. Traditional wind power plants proposed in [5] are also used, the authors give a diagram of a traction power supply system with distributed energy generation based on wind power plants.

There is also known foreign experience in the full use of the solar resource along with high-speed railways, which can become a potential solution to reduce energy costs, get more profit for railway companies [6]. Another example is the fact that the Indian Railways Modernization Expert Group has proposed

significant investments in renewable energy projects such as solar and wind power through a private and public participation initiative [7].

The purpose and objectives of research

Use of renewable energy sources within the supply systems for non-traction consumers of railway mains has proper significant features which should be taken into consideration while making relevant decisions. The key feature is as follows: such consumers connect the mains since they are far from other electric power supply networks. Hence, it will be impossible to sell the excess of the generated energy.

Much electricity will be lost even despite the fact that the guaranteed power supply of consumers, being considered, requires that the capacity of corresponding generating plants should be increased significantly under the conditions of random nature of a wind flow of solar radiation intensity. Hence, in such a case both capital costs and operational costs may increase considerably making the implementation economically impractical.

Consider some possible alternatives to use renewable energy sources in terms of the mode. First of all, determine expedience of such, in fact autonomous, application of WPPs in the context of Ukrainian regions, considered before. Making use of the dependence of a wind turbine of ZH5KW type upon the wind speed

(Fig. 1) and averaged over the

month annual distribution of the latter in the neighbourhood of Zaporizhzhia (Fig. 2), obtain indices of electric capacity of the plant for a year (Fig. 3).

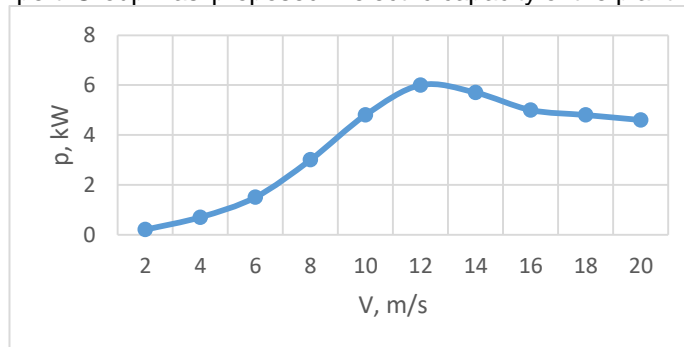

Fig. 1. Dependence of WPP capacity of ZH5KW type upon the wind speed

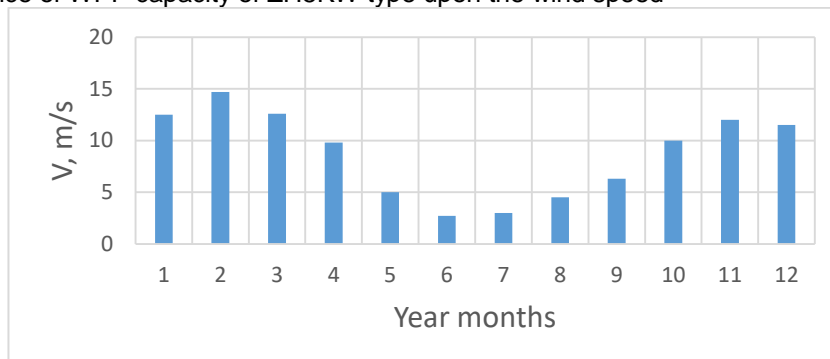

Fig. 2. Annual distribution of the monthly averaged wind velocity characteristic for the areas under consideration

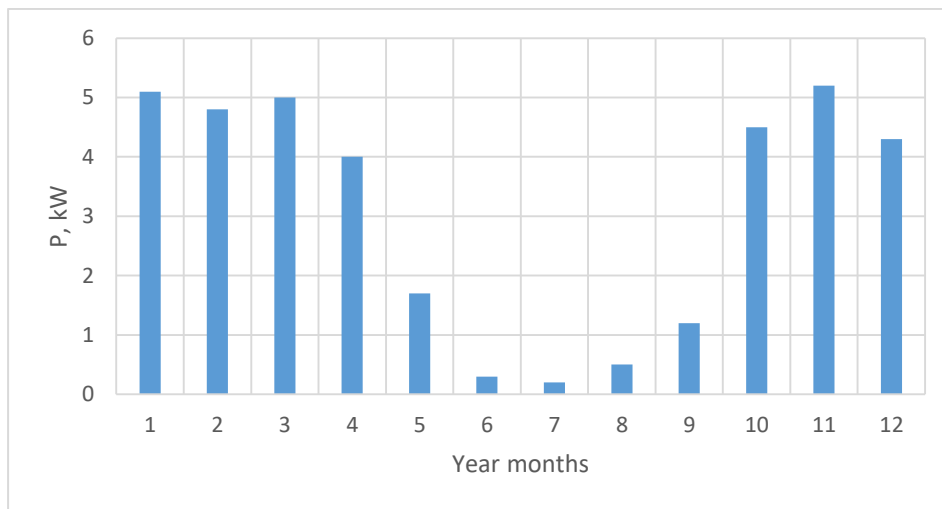

Fig. 3. Distribution of the annual electric capacity by WPP of ZH5KW type during a year in terms of its use in the neighbourhood of town of Vasylivka, Zaporizhzhia Oblast.

The obtained dependence explains that in summer WPP capacity experiences almost 25 times decrease to compare with the winter season. Thus, to provide the required capacity of such an extra source (for instance, 60 kW), 12 turbines are needed in winter and 300 ones are needed in summer. It is understood that construction of WPPs with such number of facilities, being unnecessary during the most favourable season, is a bad idea.

It goes without saying that the situation may be improved while using facilities of different types for the

WPPs. Some of them will have low critical wind speed to operate in summer with greater efficiency. They will be often disconnected in winter and energy will be generated by more powerful WPPs meant for winds being of maximum force within the area.

Krasnodon WPS can support the idea since it involves ten different installations of FL 2500 type [8]. Fig. 4 demonstrates its annual electric energy generation [9].

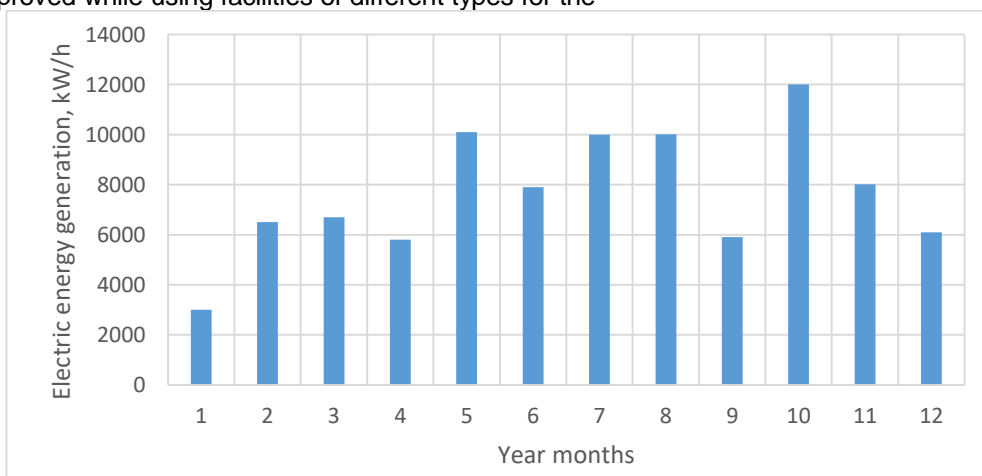

Fig. 4 Dynamics of the electric energy generation by Krasnodon WPS in 2018

However, operation in almost autonomous mode with no possibility to sell the excess of electricity in the energy market according to so-called "green" tariff is hardly expedient as well as the WPP use as a source for non-traction consumers of railway mains. Then independent use of wind turbines for the needs in the context of the considered Ukrainian regions may be regarded as impractical.

The possibility to apply photovoltaic plants looks much better. If one pays attention to the electric

power distribution by PVPs of PV-MLU250HC type, generated as it has been described in Fig. 5, it becomes obvious that it is only 3-4 times greater than in winter. Consequently, capital costs and operational costs will not be so heavy in November-February to compare with May-August if the number of PVPs is used to generate the required amount of electric energy.

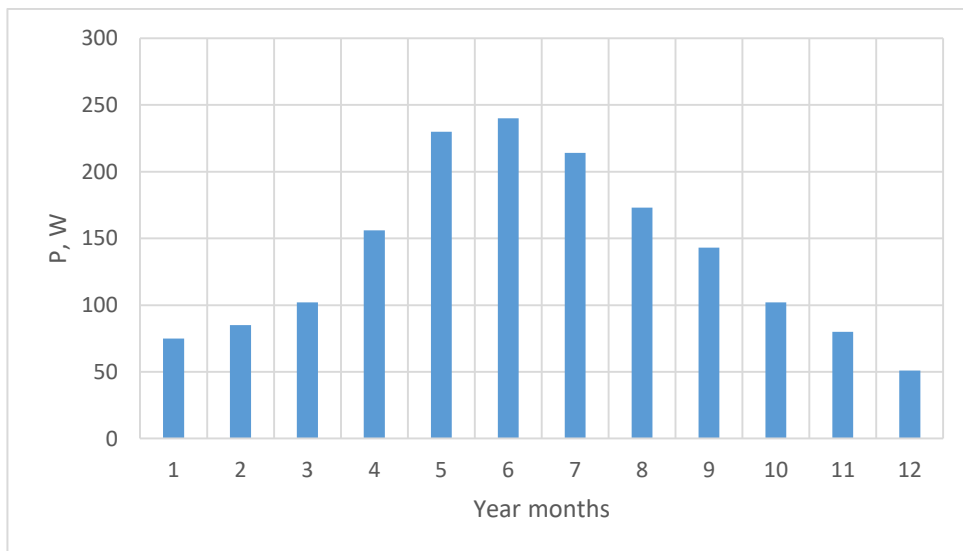

Fig. 5. Annual electric power distribution by PVPs of PV-MLU250HC type in the neighbourhood of town of Vasylivka, Zaporizhzhia Oblast.

However, use of photovoltaic plants will result in triple-quadruple excess of the electricity generated specifically in summer. Thus, such huge amount of electricity will be lost. It is unacceptable from the economic viewpoint even if loss, resulting from noisy electricity within traction railway mains, to which non-traction consumers under consideration are connected, is taken into account.

It is interesting fact that the most favourable seasons as for the use of wind and photovoltaic facilities do not coincide. Actually, they are opposite: when

WPPs are of the maximum capacity, solar panels demonstrate minimum value and vice versa. Hence, it is worth considering an alternative of the combined use of such renewable energy sources.

If the goal is set to construct such autonomous electric power station with similar 60 kW capacity generated by wind turbines in winter, then it will require 12 pieces of them. Fig. 6 (a) demonstrates annual distribution of the total average monthly capacity of the WPPs located within the territory.

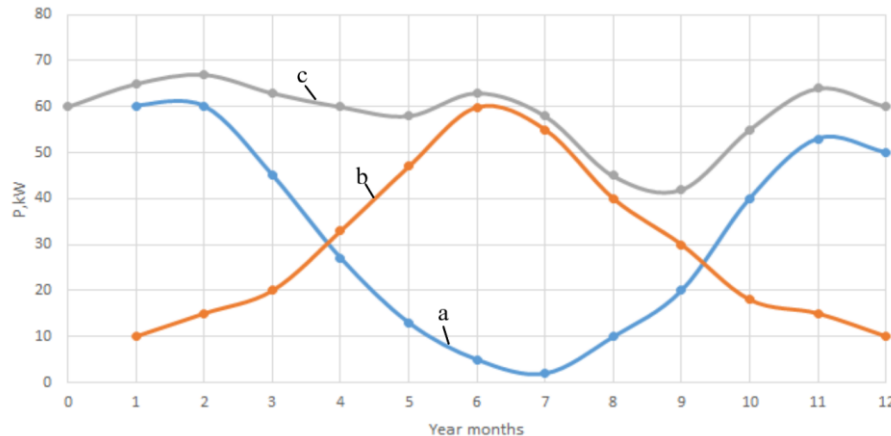

Fig. 6. Annual power distribution of wind (a), solar (b), and combined (c) generating capacities if they are constructed in the neighbourhood of town of Vasylivka, Zaporizhzhia Oblast

To cover the capacity by means of solar panels of PV-MLU250HC type in summer, they will be required 255 pieces in total. Fig. 6 (b) also demonstrates annual distribution of the total average monthly capacity by PVP. As a result of the combined use of WPP and PVP, being minimal for the case, annual capacity distribution of the power plant will look like in Fig 6 (c).

In this context, minimum excess of the generated electric energy will be available (i.e. almost 10%) in late winter-in early spring, and its deficit in the late summer-in the late autumn (i.e. no more than 25%). It is understood that the fluctuations of electricity generation amounts may be reduced drastically by means

of complete elimination of the 25% while using reasonably different types of wind turbines as it has been mentioned or with the help of minor quantity increase of one or another supply source relying upon economic considerations.

We considered three possible alternatives to use RES within the supply systems for non-traction consumers. It has been determined that their guaranteed 60 kW/h power supply will need:

- to apply only wind turbines (since their capacity is 5 kW, the number should be 300 pieces);
- to install only solar modules (since their capacity is 250 W, the number should be 800 pieces); and

– use simultaneously 12 wind turbines and 225 photovoltaic modules of the mentioned capacities.

Fig. 7 demonstrates schematic diagrams of the proposed power supply alternatives.

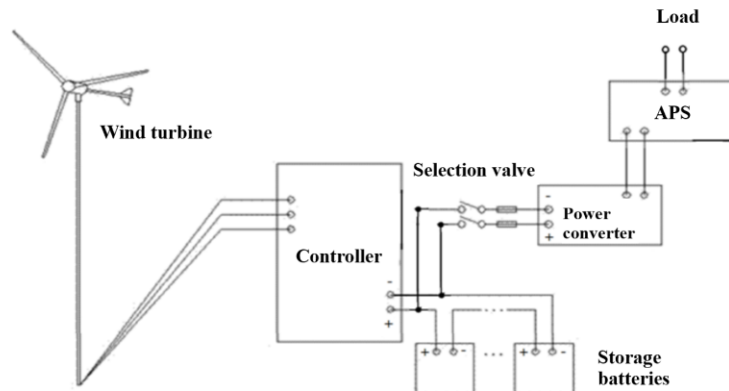

a)

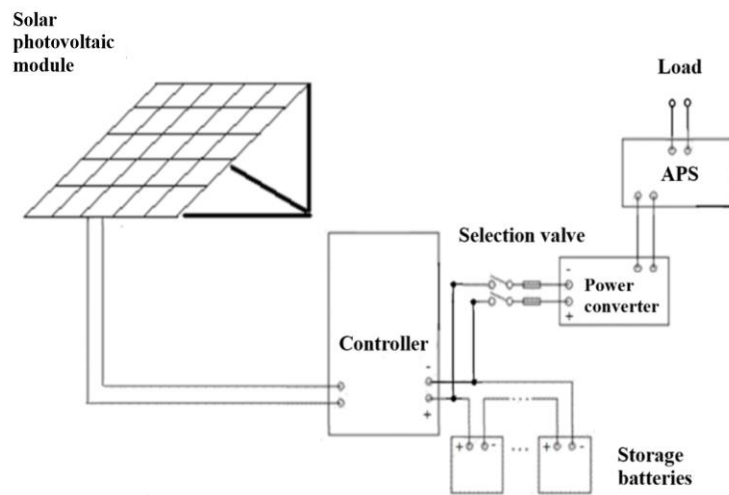

b)

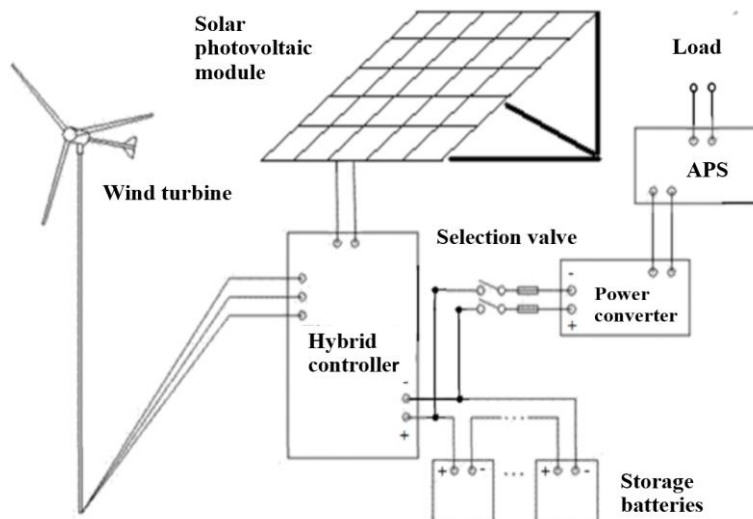

c)

Fig. 7. Schematic diagrams of wind (a), solar (b), and combined (c) electric power supply systems. APS is automated power switch for the power source

As the diagrams explain, the system will use almost similar controllers, power converters, storage

batteries, and switches in addition to supply sources. It is understood that a hybrid alternative can use mul-

tipurpose controllers with power converter functions both for wind turbines and for solar plants [10]. However, their current price still exceeds the total cost of the components taken separately. Hence, to define relative economic attractiveness of the proposed alternatives, it is quite sufficient to compare expenditures connected with the purchase of wind turbines and solar photovoltaic modules in one case or another.

Tables 1 and 2 demonstrate technical and economic indicators of the most popular home-produced solar photovoltaic modules and wind turbines being of the mentioned capacities. It is obvious that if a tender to purchase the equipment is held then solar photovoltaic modules Solar KD– 250P by EKO-ST Company (Ukraine) at the cost of UAH 5400 per unit and wind turbines Euro–Wind–5 by Eko–Raduga ltd at the cost of UAH 125.000 per unit would be used.

Table 1

Technical-and-economic indicators of solar photovoltaic modules by EKO-ST Company (Ukraine, eco.st.lv@gmail.com)

Model	Nominal capacity, W	Nominal voltage, V	Voltage x. x., V	Price, UAH
KVAZAR KV 250P	250	30.7	37.3	10500
ALTEK ACS-250D	250	31.4	37.2	8100
SOLAR KD-250P	250	30.8	37.43	5400

Relying upon the abovementioned, cost of the power stations in terms of alternative one of WPP implementation would be UAH 37500 thousand under the conditions of nonavailability of electric energy by traction mains. The price would be UAH 4320 thousand

in terms of alternative two. If the combined alternative is used (i.e. when the number of wind turbines and solar photovoltaic modules is quite less to compare with the previous cases) then the total cost of the required quantity is UAH 2877 thousand only.

Table 2

Technical and economic indicators of the current WPP

Manufacturer	Model	Capacity, kW	Voltage, V	Wind speed, m/s		Tower, m	Price, UAH thous.
				initial	rated		
MikroART ltd, Ukraine Vetrogenerator.ru	5/7 KW-480 LOW WIND	5 7 (max)	48	3	8	12	215
	FDV-5KW	5 7 (max)	48	2,5	10	8	549
Energo-Star ltd, Ukraine www.energostar.com.ua	Euro Wind 5	5 7 (max)	240	2	8	12	330
Eko–Raduga ltd, Ukraine www.ecoraduga.com	Euro–Wind–5	6 7 (max)	240	2,5	12	12	125
ALTAL GrupSrl, Moldova http://www.altalgrup.com	ALTAL - 5	5 6 (max)	240	2	10	12	170

**Conclusion**

Consequently, the use of wind turbines only is the worst alternative from the economic viewpoint; moreover, it is almost unacceptable. The combined alternative is the cheapest one; however, it is still too expensive to be implemented. It is understood that tradi-

tional supply sources should also be applied in the case. Nevertheless, the problem concerning the ratio between electric power supply using them and RES, and how the mains of non-traction consumers should be constructed needs further consideration.

**REFERENCES**

1. Konovalova A. Renewable energy potential for the South Ural Railway / A.A. Konovalova, I. M. Kirpichnikova // Energy and resource saving. Power supply. Non-traditional and renewable energy sources: materials of the International scientific-practical conference of students, graduate students and young scientists, dedicated to the memory of Professor Danilov NI (1945-2015) - Danilov readings (Ekaterinburg, December 11-15, 2017). - Ekaterinburg: URAL FEDERAL UNIVERSITY, 2017. — P. 804-807.

2. Sushchenko, K.B., Polyah, O.M. Optimization Supplied Electricity at the Use of Non-Traditional Power Sources. Electromagnetic compatibility and safety in railway transport. – 2017. – № 14. – pp. 80–85. — DOI: 10.15802/ecsrt2017/137789.
3. Asensio, F.J., San Martín, J.I., Zamora, I., Oñederra, O., Saldaña, G., Eguia, P. A system approach to harnessing wind energy in a railway infrastructure. IECON 2018 - 44th Annual Conference of the IEEE Industrial Electronics Society, 26 December 2018, pp. 1646-1651.
4. Measurement of the aerodynamic pressures produced by passing trains : (Proceedings of the 2002 ASME/IEEE Joint Rail Conference Washington, DC, April 23-25, 2002) [Электронний ресурс] / Robert A. MacNeill and Samuel Holmes. – Режим доступу: <http://www.acusim.com/papers/Train-Aero-Paper.pdf>
5. Kotelnikov, A.V., Shevlyugin, M.V., Zhumatova, A.A. Distributed generation of electric energy in traction power-supply systems of railways based on wind-power plants. Russian Electrical Engineering Volume 88, Issue 9, 1 September 2017, Pages 586-591.
6. Zhong, Z., Zhang, Y., Shen, H., Li, X. Optimal planning of distributed photovoltaic generation for the traction power supply system of high-speed railway(2020) Journal of Cleaner Production, 263, DOI: 10.1016/j.jclepro.2020.121394
7. Mane, S.D., Nagesha, N. Adoption of renewable energy technologies in Indian Railways: A case study of two workshops(2015) Energy Security and Development: The Global Context and Indian Perspectives, pp. 247-258. DOI: 10.1007/978-81-322-2065-7\_16
8. Open data portal. [E-resource] <http://data.gov.ua>
9. Budko, V.I. Autonomous power centers based upon renewable power sources with different systems of energy accumulation/ V.I. Budko // Renewable energy. -2015. - № 2. - Pp.21-25.
10. Lezhniuk, P.D., Rubanenko, O.Ye., Hunko, I.O. Influence of SEP inverters on the electric energy quality indices of LPP/ P.D. Lezhniuk, O.Ye. Rubanenko, I.O. Hunko // Messenger of Khmelnytsky National University, 2015, № 2 (223).- Pp. 134-145.

*Стаття поступила: 04.09.2019*